

Notice de montage / Assembly instructions









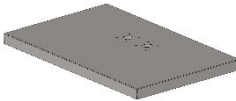

XENON WIDE simple écran / XENON WIDE single screen



Composition / Packing list :

- Colis N°1 : socle + accessoires

Package N°1 : base + accessories

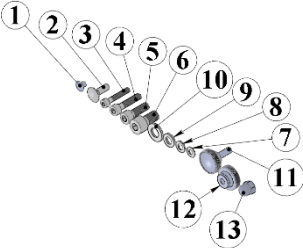
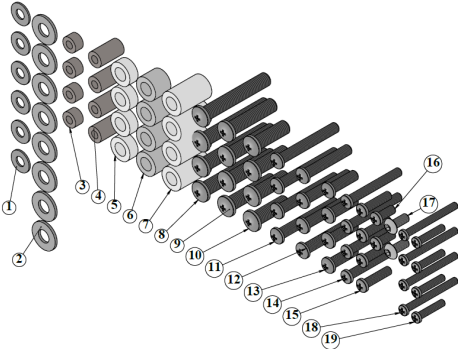
Socle + habillage Base + cover																																																																																			
																																																																																			
	4 Patins téflons 4 Teflon pads	4 roulettes Ø35 4 casters Ø35	4 roulettes Ø100 4 casters Ø100																																																																																
Paire de fixations fixes Mounting brackets																																																																																			
1 barre VESA 1 VESA bar																																																																																			
Une multiprise (unavailable for UK/DE)																																																																																			
8 Colliers de serrage 8 plastic clamps																																																																																			
Un jeu de clés Allen key set																																																																																			
Un kit visserie meuble Bolting kit (furniture)	 <table border="1"> <thead> <tr> <th>Rep</th> <th>Qté</th> <th>Désignation</th> </tr> </thead> <tbody> <tr><td>1</td><td>16</td><td>Bouchon M5</td></tr> <tr><td>2</td><td>4</td><td>Vis japy M5x15</td></tr> <tr><td>3</td><td>2</td><td>Vis CHC M4x25</td></tr> <tr><td>4</td><td>2</td><td>Vis CHC M5x25</td></tr> <tr><td>5</td><td>12</td><td>Vis CHC M6x20</td></tr> <tr><td>6</td><td>6</td><td>Vis CHC M8x16</td></tr> <tr><td>7</td><td>2</td><td>Rondelle plate M4</td></tr> <tr><td>8</td><td>2</td><td>Rondelle plate M5</td></tr> <tr><td>9</td><td>12</td><td>Rondelle plate M6</td></tr> <tr><td>10</td><td>6</td><td>Rondelle plate M8</td></tr> <tr><td>11</td><td>8</td><td>Vis molette M5</td></tr> <tr><td>12</td><td>4</td><td>Ecrou moleté M5</td></tr> <tr><td>13</td><td>4</td><td>Ecrou borgne M6</td></tr> </tbody> </table>			Rep	Qté	Désignation	1	16	Bouchon M5	2	4	Vis japy M5x15	3	2	Vis CHC M4x25	4	2	Vis CHC M5x25	5	12	Vis CHC M6x20	6	6	Vis CHC M8x16	7	2	Rondelle plate M4	8	2	Rondelle plate M5	9	12	Rondelle plate M6	10	6	Rondelle plate M8	11	8	Vis molette M5	12	4	Ecrou moleté M5	13	4	Ecrou borgne M6																																						
Rep	Qté	Désignation																																																																																	
1	16	Bouchon M5																																																																																	
2	4	Vis japy M5x15																																																																																	
3	2	Vis CHC M4x25																																																																																	
4	2	Vis CHC M5x25																																																																																	
5	12	Vis CHC M6x20																																																																																	
6	6	Vis CHC M8x16																																																																																	
7	2	Rondelle plate M4																																																																																	
8	2	Rondelle plate M5																																																																																	
9	12	Rondelle plate M6																																																																																	
10	6	Rondelle plate M8																																																																																	
11	8	Vis molette M5																																																																																	
12	4	Ecrou moleté M5																																																																																	
13	4	Ecrou borgne M6																																																																																	
Un kit visserie écran Bolting kit (screens)	 <table border="1"> <thead> <tr> <th>Rep</th> <th>Qté</th> <th>Désignation</th> <th>Désignation</th> </tr> </thead> <tbody> <tr><td>1</td><td>6</td><td>Rondelle M6</td><td>Washer M6</td></tr> <tr><td>2</td><td>8</td><td>Rondelle plate M8</td><td>Washer M8</td></tr> <tr><td>3</td><td>4</td><td>Ecartouche Ø10xØ5 lg 6</td><td>Spacer Ø10xØ5 lg 6</td></tr> <tr><td>4</td><td>4</td><td>Ecartouche Ø10xØ5 lg 18</td><td>Spacer Ø10xØ5 lg 18</td></tr> <tr><td>5</td><td>4</td><td>Ecartouche Ø15xØ8,4 lg 6,3</td><td>Spacer Ø15xØ8,4 lg 6,3</td></tr> <tr><td>6</td><td>4</td><td>Ecartouche Ø15xØ8,4 lg 12</td><td>Spacer Ø15xØ8,4 lg 12</td></tr> <tr><td>7</td><td>4</td><td>Ecartouche Ø15xØ8,4 lg 24</td><td>Spacer Ø15xØ8,4 lg 24</td></tr> <tr><td>8</td><td>4</td><td>Vis cruciforme M8x50</td><td>Cross-headed screw M8x50</td></tr> <tr><td>9</td><td>4</td><td>Vis cruciforme M8x35</td><td>Cross-headed screw M8x35</td></tr> <tr><td>10</td><td>4</td><td>Vis cruciforme M8x25</td><td>Cross-headed screw M8x25</td></tr> <tr><td>11</td><td>4</td><td>Vis cruciforme M6x45</td><td>Cross-headed screw M6x45</td></tr> <tr><td>12</td><td>4</td><td>Vis cruciforme M6x35</td><td>Cross-headed screw M6x35</td></tr> <tr><td>13</td><td>4</td><td>Vis cruciforme M6x20</td><td>Cross-headed screw M6x20</td></tr> <tr><td>14</td><td>4</td><td>Vis cruciforme M5x40</td><td>Cross-headed screw M5x40</td></tr> <tr><td>15</td><td>4</td><td>Vis cruciforme M5x20</td><td>Cross-headed screw M5x20</td></tr> <tr><td>16</td><td>2</td><td>Vis cruciforme M5x12</td><td>Cross-headed screw M5x12</td></tr> <tr><td>17</td><td>2</td><td>Vis CBHC M5x12</td><td>Screw CBHC M5x12</td></tr> <tr><td>18</td><td>4</td><td>Vis cruciforme M4x40</td><td>Cross-headed screw M4x40</td></tr> <tr><td>19</td><td>4</td><td>Vis cruciforme M4x20</td><td>Cross-headed screw M4x20</td></tr> </tbody> </table>			Rep	Qté	Désignation	Désignation	1	6	Rondelle M6	Washer M6	2	8	Rondelle plate M8	Washer M8	3	4	Ecartouche Ø10xØ5 lg 6	Spacer Ø10xØ5 lg 6	4	4	Ecartouche Ø10xØ5 lg 18	Spacer Ø10xØ5 lg 18	5	4	Ecartouche Ø15xØ8,4 lg 6,3	Spacer Ø15xØ8,4 lg 6,3	6	4	Ecartouche Ø15xØ8,4 lg 12	Spacer Ø15xØ8,4 lg 12	7	4	Ecartouche Ø15xØ8,4 lg 24	Spacer Ø15xØ8,4 lg 24	8	4	Vis cruciforme M8x50	Cross-headed screw M8x50	9	4	Vis cruciforme M8x35	Cross-headed screw M8x35	10	4	Vis cruciforme M8x25	Cross-headed screw M8x25	11	4	Vis cruciforme M6x45	Cross-headed screw M6x45	12	4	Vis cruciforme M6x35	Cross-headed screw M6x35	13	4	Vis cruciforme M6x20	Cross-headed screw M6x20	14	4	Vis cruciforme M5x40	Cross-headed screw M5x40	15	4	Vis cruciforme M5x20	Cross-headed screw M5x20	16	2	Vis cruciforme M5x12	Cross-headed screw M5x12	17	2	Vis CBHC M5x12	Screw CBHC M5x12	18	4	Vis cruciforme M4x40	Cross-headed screw M4x40	19	4	Vis cruciforme M4x20	Cross-headed screw M4x20
Rep	Qté	Désignation	Désignation																																																																																
1	6	Rondelle M6	Washer M6																																																																																
2	8	Rondelle plate M8	Washer M8																																																																																
3	4	Ecartouche Ø10xØ5 lg 6	Spacer Ø10xØ5 lg 6																																																																																
4	4	Ecartouche Ø10xØ5 lg 18	Spacer Ø10xØ5 lg 18																																																																																
5	4	Ecartouche Ø15xØ8,4 lg 6,3	Spacer Ø15xØ8,4 lg 6,3																																																																																
6	4	Ecartouche Ø15xØ8,4 lg 12	Spacer Ø15xØ8,4 lg 12																																																																																
7	4	Ecartouche Ø15xØ8,4 lg 24	Spacer Ø15xØ8,4 lg 24																																																																																
8	4	Vis cruciforme M8x50	Cross-headed screw M8x50																																																																																
9	4	Vis cruciforme M8x35	Cross-headed screw M8x35																																																																																
10	4	Vis cruciforme M8x25	Cross-headed screw M8x25																																																																																
11	4	Vis cruciforme M6x45	Cross-headed screw M6x45																																																																																
12	4	Vis cruciforme M6x35	Cross-headed screw M6x35																																																																																
13	4	Vis cruciforme M6x20	Cross-headed screw M6x20																																																																																
14	4	Vis cruciforme M5x40	Cross-headed screw M5x40																																																																																
15	4	Vis cruciforme M5x20	Cross-headed screw M5x20																																																																																
16	2	Vis cruciforme M5x12	Cross-headed screw M5x12																																																																																
17	2	Vis CBHC M5x12	Screw CBHC M5x12																																																																																
18	4	Vis cruciforme M4x40	Cross-headed screw M4x40																																																																																
19	4	Vis cruciforme M4x20	Cross-headed screw M4x20																																																																																
Notice de montage Assembly instruction																																																																																			

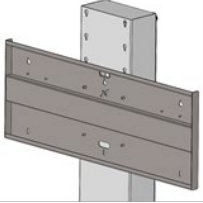
OPTIONS		
<p><i>Un support codec</i> Codec holder</p>	<p>SCUV12</p>	
<p><i>Fixation forte charge</i> Heavy load screen fixing</p>	<p>KIT ADT 75 100</p>	

- Colis N°2 : colonne avec carter + trappe avant
Package N°2 : column with rear cover + front hatch

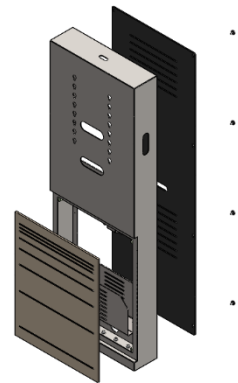

NOTICE DE MONTAGE / ASSEMBLY INSTRUCTIONS

Etape 1 :

- Selon l'option choisie, assembler les patins téflons ou les roulettes Ø35 ou les roulettes Ø100
- Puis, placer l'habillage sur le socle

Step 1 :

- *According to the option, fix the Teflon pads or the Ø35 castors or the Ø100 casters*
- *Then, place the cover on the base*

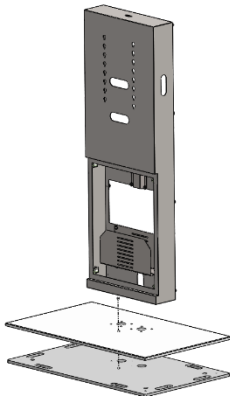
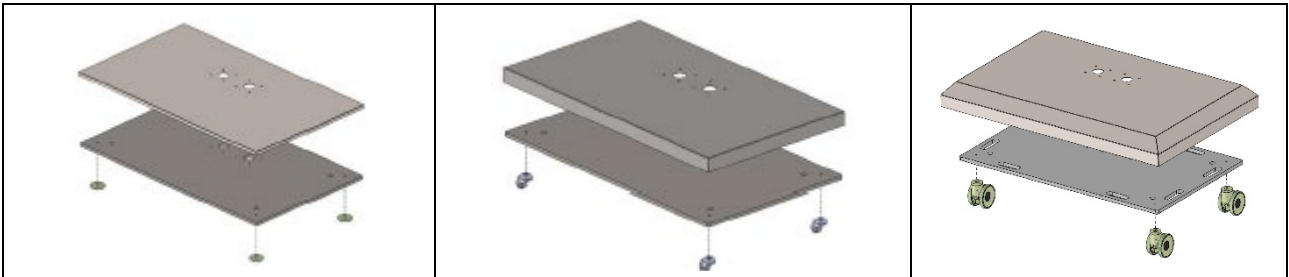

Etape 2 :

- Monter la colonne sur le socle
(8 rondelles M8 + 8 vis CHC M8x20)

Step 2 :

- *Fix the column to the base (8 CHC M8x20 screws + 8 M8 washers)*

Etape 3 :

Step 3 :

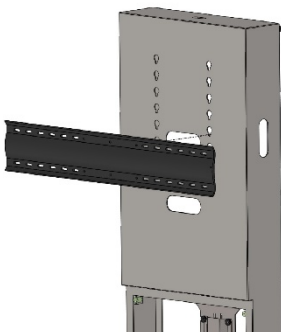
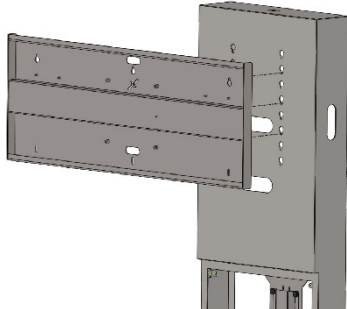
Barre VESA	FORTE CHARGE (option)
<ul style="list-style-type: none"> • Monter la barre VESA sur la colonne (5 positions possibles) (4 Vis CHC M6x20 + 8 rondelles M6 + 4 écrous M6) • <i>Mount the VESA bar onto the column (5 possible positions) (4 screws CHC M6x20 + 8 washers M6 + 4 nuts M6)</i> 	<ul style="list-style-type: none"> • Monter le support forte charge sur la colonne (4 positions possibles) (6 Vis M8x20) • <i>Mount the heavy load screen fixing on the column (4 possible positions) (6 M8x20 screws)</i>
	

Etape 4 : (option support codec)

Step 4 : (codec holder option)

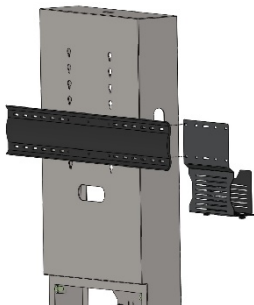
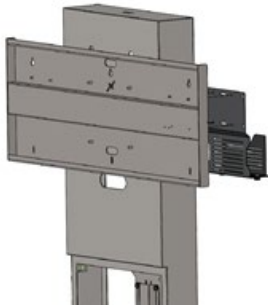
Barre VESA	FORTE CHARGE (option)
<ul style="list-style-type: none"> • Monter le support codec derrière la barre VESA (4 vis tête bombé carré M5x20 + 4 écrous moletés M5) • <i>Fix the codec holder behind the VESA bar (4 Screws CBHC M5x20 + 4 Knurled screws M5)</i> 	<ul style="list-style-type: none"> • Monter le support codec derrière la support forte charge (4 vis moletées M5) • <i>Mount the codec holder behind the heavy load screen fixing (4 knurled screws M5)</i>
	

Etape 5 :

- Monter la paire de fixations fixes sur l'écran (vis fournies dans le kit visserie écran)

Step 5 :

- *Fix the mounting brackets on the screen (screws provided in the bolting kit)*

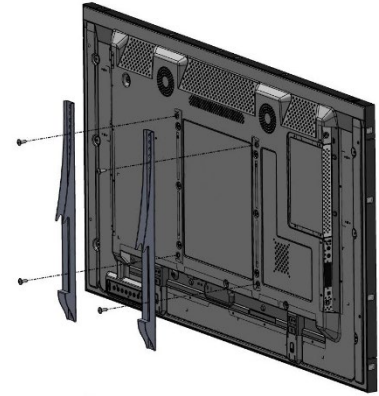

Etape 6 :

- Monter l'écran sur la barre VESA
- Sécuriser l'écran (vis fournies dans le kit visserie écran)

Step 6 :

- *Fix the screen on the VESA bar*
- *Secure the screen (screws provided in the bolting kit)*

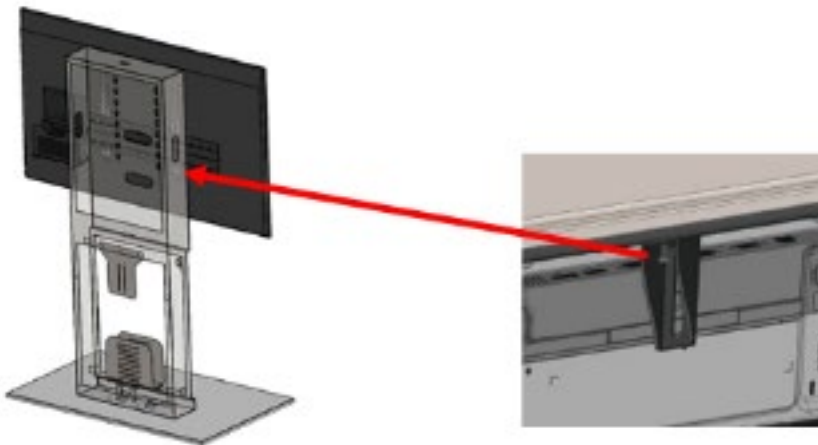

Warning :

Tightening just in contact.
Do not tighten too hard

Attention :

Serrage juste en contact.
Ne pas serrer trop fort

Etape 7 :

- Procéder au câblage

Step 7 :

- *Proceed with cabling*

Etape 10 :

- Retirer les films de protection du carter avant de le monter sur la colonne (8 vis moletées M5)
- Positionner la trappe d'accès

Step 10 :

- *Remove the protective film of the rear cover before fitting them on the column (8 knurled screws M5)*
- *Position the access hatch*

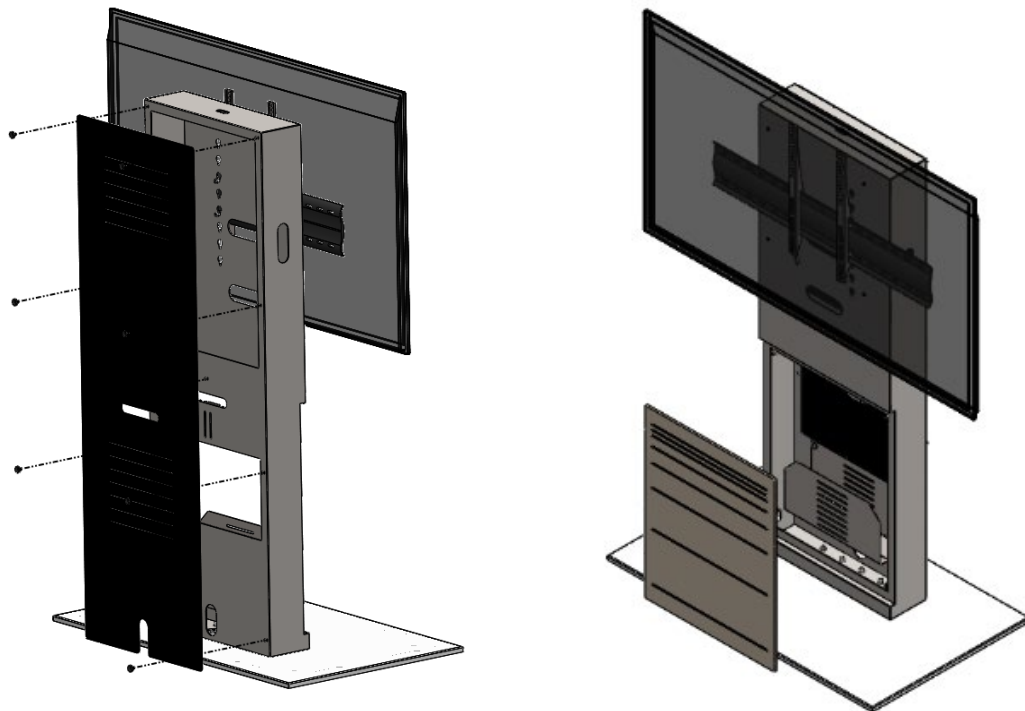

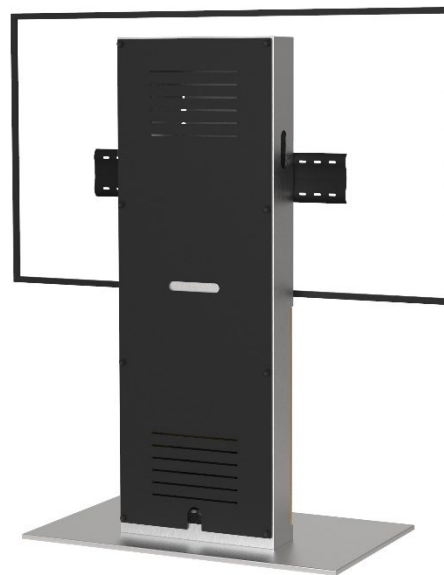

Le montage de votre XENON WIDE est terminé !

Your XENON WIDE is ready !